

AVANT[®]

420/423

Operator's Manual 2018-



TABLE OF CONTENTS

Table of contents	2	Coupling the hydraulic hoses of the attachment....	25
Introduction	3	Make sure that the attachment	
Safety instructions	4	is locked to the loader.....	25
Warranty	6	Releasing the pressure of hydraulic system.....	25
Description of the loader	7	Service and maintenance instructions	27
Loader identification.....	7	Safety instructions for maintenance.....	28
Engine identification.....	7	Installing of service support and frame lock.....	28
Main parts of the loader.....	8	Daily inspections.....	29
Signs and decals.....	9	Maintenance schedule.....	29
Technical specification.....	10	Cleaning of the machine.....	30
Engine specification.....	11	Greasing of the machine.....	30
Tyres.....	11	Battery check.....	30
Auxiliary hydraulics oil flow.....	11	Hydraulic oil level.....	30
Load diagram.....	12	Check coolant level.....	30
Transporting instructions and tie down points.....	12	Hydraulic oil filter change.....	30
Operating instructions	13	Hydraulic oil change.....	30
Operating controls.....	14	Check and tightening of bolts, nuts etc.....	31
Control of loader boom, auxiliary hydraulics and other functions.....	15	Check of hydraulic pressure.....	31
Attachment control switch pack.....	15	Adjustment of hydraulic pressure.....	31
Dashboard.....	16	Adjust and change of slide pads on telescopic boom...32	
Controls in the footwell.....	16	Clean air filter element.....	32
Suspension seat.....	17	Service, engine.....	33
Seat belt and seat adjustments.....	17	Fuses.....	33
Telescopic boom.....	17	Hydraulic oil cooler fan fuse.....	34
Battery disconnect switch.....	17	Jump start and auxiliary power.....	34
Seat heater.....	18	Storage of the machine.....	34
Boom floating.....	18	Refueling.....	34
Joystick.....	18	Metal structures of the loader.....	34
Engine block heater.....	18	Greasing points.....	35
Trailer coupling.....	19	Light bulbs.....	35
Extra counterweights.....	19	Filters.....	36
Work light kit.....	19	Troubleshooting.....	37
Headlight, beacon, blinker & reflector kit.....	19	Service history	38
Tilt adapter.....	19	EC Declaration of Conformity	39
Drive release valve.....	19		
Anti slip valve.....	19		
Extra auxiliary hydraulics outlets, front and rear....	20		
Warning beacon.....	20		
Cab L.....	20		
Starting the engine.....	21		
Stopping the engine.....	21		
Drive control.....	22		
Steering of the machine.....	23		
Loader control.....	23		
Using the auxiliary hydraulics.....	23		
Requirements for attachments.....	24		
Coupling the attachments.....	24		

Introduction

AVANT TECNO OY wants to thank you for purchasing this AVANT loader. It is the result of Avant's long experience in design and manufacturing of compact loaders. We ask you that you read and understand the contents of this manual completely before operating the loader. This operator's manual is intended to help you to:

- operate this machine safely and efficiently
- observe and prevent situations that may cause a risk or danger
- keep the machine in good condition and its life span as long as possible

Following symbols are used throughout this Manual to point out important things related to safety:



This safety symbol indicates important safety instructions in this Manual. It warns of an immediate hazardous situation that can cause serious personal injuries or property damages. Read carefully the warning text next to this symbol and make sure that all other operators are aware of the warnings as well. It is a question of safety of persons.



This attention symbol indicates important instructions concerning correct use and maintenance of this machine. If these instructions are not followed, the consequence can be breakdown of the machine or property damage.

Contact your local AVANT dealer for any questions, service, spare parts or about any problems that may occur with the operation of your machine.

Keep this Operators Manual with the machine at all times. If this Manual gets lost, ask for a new copy from your Avant dealer. Remember also to give this Manual to the new owner when the machine changes ownership.



In addition to this Operator's manual of the loader, ensure that you have received and read also the original Engine owner's manual. The instructions concerning the engine, must be followed. If conflicting information is found, the information shown in the Operator's Manual of the loader must be followed.

Each attachment is accompanied by its



own respective Operator's Manual. The manual will show important information related to safety, and how to attach, use, and maintain each attachment correctly.

Intended use

AVANT 420/423 is an articulated compact loader, designed and manufactured for both professional and private use. The loader can be equipped with attachments offered by Avant Tecno Oy, which enables doing of several different jobs. Because of this multi purpose nature of the machine and the various attachments and tasks, read always not only this Manual but also the Operators Manual of the attachment, and follow all instructions. Every person who has to do with this machine must follow work safety regulations, all other generally accepted rules related to work health and safety, and all road traffic regulations.

Remember that safety consists of several factors. The loader, equipped with an attachment is very powerful and can cause serious personal injuries or property damages if it is operated in a wrong or careless way. Do not operate an attachment unless you have familiarised yourself with the use of it and the eventual dangers related to it.

This loader has been designed to require as little maintenance as possible. The operator can perform the routine maintenance operations. There are however more demanding service operations that can be done by professional service personnel only. It is allowed to perform service operations only when wearing appropriate protective equipment. Original spare parts must be used. Familiarise yourself with the service and maintenance instructions in this Manual.

Contact your local AVANT dealer, if you are uncertain of anything concerning the operation and maintenance of this loader, or for any questions, service or spare parts.

Safety first



An incorrect or careless operation of the loader may be the origin of a serious accident. Before putting the machine into operation, familiarise yourself with the use of the machine and read and understand this Operators Manual as well as the safety instructions.

Understand the limitations of speed, braking, steering and stability as well as loading capacity of the machine before starting operation. Make sure that every one who operates or works with this equipment is familiar with these safety precautions.

If you have no previous experience of the machine, make sure to do all testing at a safe and open place with no persons in the area of operation.



Read this Operators Manual, and also the Operators Manual of the attachment(s) and other safety instructions before starting operation

General instructions

1. Remember the correct working position. When driving be comfortably seated in the driver's seat, keep your feet in their proper place in the footwell and at least one hand on the steering wheel.
2. When seated, always keep the seat belt fastened and keep hands and feet inside the operator's area.
3. Start the operation slowly and carefully. Practice driving of the machine at a safe and open place before connecting any attachment, follow the instructions in this Manual.
4. Operate the control levers with ease and without hesitation. Avoid abrupt movements when handling the load, in order to prevent the load from falling and to keep the machine stable.
5. Keep away from the danger zone of the lifted boom and don't let anyone go there.
6. Keep your hands, feet and clothing away from all moving parts, hydraulic components and hot surfaces.
7. Make sure that there is enough open space around the machine for safe driving.
8. Do not transport the load with the boom lifted. Always carry bucket or attachment as low as possible, and put the load down whenever you leave the machine.

9. Before leaving driver's seat:
 - Lower the loader boom and place attachment flat on ground
 - Engage the parking brake
 - Stop the engine, remove the ignition key
10. It is not allowed to transport persons with this machine. Do not transport or lift persons in the bucket or in any other attachment. Lifting of persons is only allowed with the attachment designed for this purpose: Avant Leguan 50, following the instructions in the Operators Manual of Leguan 50.
11. Do not exceed rated operating capacity. Familiarise yourself with and follow the load diagrams in this Manual.
12. When turning with the machine, remember that the driver's seat extends beyond the turning radius of the wheels (collision risk).
13. Do not operate the loader in an explosive environment or in a place where dust or/and gases can create a fire or explosion hazard.
14. Keep the engine area clean of flammable materials.
15. Read the transportation instructions on page 12.
16. Switch off the battery disconnect switch whenever leaving the machine unattended.
17. Follow all inspection, service and maintenance instructions. If you notice any faults or damages on the machine, these must be repaired before starting operation.
18. Before any maintenance or repair operation always stop the engine, lower the boom down and release pressure from hydraulic system. Read safety instructions for maintenance on page 28.
19. Do not let any person operate this loader who has not read safety instructions and is not familiar with the safe and correct use of this loader.

Operation on gradients

20. Load, unload, and turn on flat level ground only. Drive slowly on uneven terrains. Do not drive on too steep a gradient - watch out for ditches, manholes and steep gradients.
21. Do not park the machine on a surface with a gradient. Should this be necessary, engage the parking brake and preferably turn the machine sideways and put down the load. If needed, use chocks behind the wheels.
22. Use low speed range when driving on hills or uneven terrain.

Handling of heavy loads



Never take a heavy load on the loader from high level – e.g. from truck, shelf etc. – risk of tipping over!

Always put the load down on the ground before leaving the machine. When loading, always keep the loader chassis as straight as possible.

Personal safety and protective equipment

Wear safe clothing and personal protective equipment (PPE). Protect yourself against work hazards like noise, ejecting debris or dust for example.



- Noise level at driver's seat can exceed 85 dB(A). Wear hearing protection when working with the loader.
- It is recommended to wear safety footwear when working with the loader.
- Wear protective gloves when handling hydraulic hoses.
- Follow regulations regarding protective equipment. Wear eye protection and hard hat or other protective equipment as needed.

Read Operators Manual of the attachment for more information about protective equipment needed in the work.

Safety frame (ROPS) and safety canopy (FOPS)



Safety frame (ROPS) protects the operator in case the machine tips over. Always fasten the seat belt in order to stay inside the safety frame protective area.

The loader is also equipped with a falling objects protective canopy (FOPS). Never take off the safety structures, modify them, or attempt to repair. If damaged, contact service.

Electric system and handling the battery

Lead acid batteries can produce flammable and explosive gases. Make sure that the ventilation is sufficient and keep arcs, sparks, flames and lighted tobacco away from battery.

- Battery contains corrosive sulfuric acid.
- Avoid contact with skin or clothes. If electrolyte gets on your skin or clothes, flush with a lot of water.
- In case of contact with eyes, flush with a lot of water for at least 15 minutes and consult a doctor immediately.
- Never charge a frozen battery.
- In order to avoid spark emissions always disconnect the negative (-) cable first and connect it last.
- Before connecting the battery cables make sure that the polarity is correct: faulty connection will seriously damage the electric system of the engine.
- Disconnect the battery before working on the engine or equipment.
- Read the instructions for jump start on page 33.

Fire prevention

Clean the loader to avoid build-up of flammable debris, such as dust, leaves, hay, straw, etc.

- There are many parts on the electric system that operate at high temperatures in normal use. To avoid fire, and to ensure that the cooling of electric systems is ensured, keep the electric parts clean. Overheating of electric parts can shorten their service life.
- **Static electricity can produce sparks when removing plastic covers.**
- Do not smoke while you work near the battery, or do any maintenance work of the hydraulic system.
- Add hydraulic oil only at a well ventilated place.
- Oil leaks can ignite on hot components. Repair any damaged or leaking components before using machine.

Know where fire extinguishing equipment is located near your working site. At some areas a fire extinguisher may be mandatory. Keep a multi-purpose, approved type fire extinguisher available near the place where you store the loader.

Avant 420/423 warranty

This warranty specifically applies to the AVANT 420/423 loader only and not to any attachments used with this product. Any repairs or modifications performed without the prior authorisation of Avant Tecno Oy will cancel this warranty.

During the first two years of operation or first 750 hours (whichever is the soonest) Avant Tecno Oy warrants to replace any part or repair any defect which may occur, subject to the terms detailed below:

- 1) The product has received regular maintenance in accordance with schedules given by the manufacturer.
- 2) Any damage caused by operation in a negligent manner or exceeding the approved specifications detailed in this manual is excluded.
- 3) Avant Tecno Oy accepts no responsibility for interruption to working or any other consequential losses resulting from any failure of the product.
- 4) Only Avant Tecno Oy approved replacement or original quality parts shall be used during routine maintenance.
- 5) Any damage caused by the use of incorrect fuel, lubricants, cooling liquid or cleaning solvents is excluded.
- 6) The Avant Warranty excludes any consumable parts (e.g. tyres, batteries, filters, belts etc.) except where it can be clearly shown that these parts were defective on original supply.
- 7) Any damage caused resulting from the use of attachments not approved for use with this product is excluded.
- 8) In the event a fault occurs which is attributable to manufacturing or assembly defect you should arrange to return your AVANT to your authorised dealer for repair. Travel and freight costs are excluded.

Description of the loader

Identification of the loader

Write down the identification information of your loader in the following fields, it facilitates ordering of spare parts etc.

1. Loader model _____

2. Loader serial no. _____

3. Engine serial no. _____

Serial number of the loader is printed on the type plate (see page 9), which also indicates the loader model. Location of engine serial number can be found in the Operators Manual of the engine.

Dealer: _____

Contact information: _____

Loader identification

Loader identification plate is located near the steering wheel on machines with ROPS canopy and cab L



Engine identification

Engine identification plate is located on the valve cover.

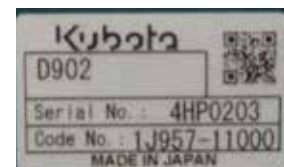

Main parts of the loader

Following picture shows the main parts of the loader:

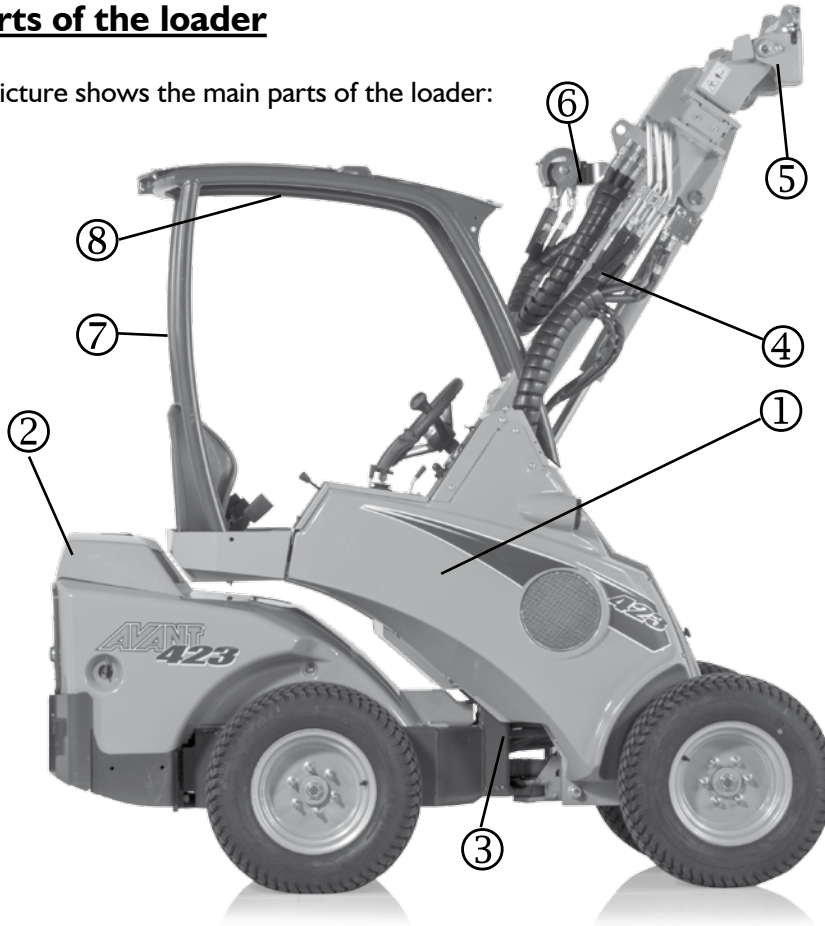

Hydraulic connectors Multi connector



① Front frame

On the front frame are mounted: driver's seat, operating controls, parking brake, hydraulic control valves, hydraulic oil tank, auxiliary hydraulics outlet, front wheels, hydraulic motors and the loader boom with attachment coupling plate.

② Back frame

On the back frame are mounted: engine with accessories, battery, fuel tank, hydraulic pumps, rear wheels, hydraulic motors, counterweights.

③ Articulation joint

Articulation joint connects the front and back frame. The loader is steered hydraulically by the steering cylinder which is mounted between the front and back frames. Hydraulic hoses and electric wires are conducted through the articulation joint.

④ Loader boom

Loader boom is mounted on the front frame with one pivot pin. The attachment coupling plate is mounted on the lower end of the boom. The boom can be telescopic, extending 600 mm hydraulically.

⑤ Attachment coupling plate

Attachments are mounted on the attachment coupling plate. The locking pins on the plate can be operated manually (standard) or hydraulically (option).

⑥ Auxiliary hydraulics outlet

The hydraulic hoses of hydraulically operated attachments are mounted on this outlet. The outlet is equipped with the multi connector quick coupling system and is double acting: it has two pressure lines and one tank line. Also the optional attachment control switch pack socket is mounted on the multi connector. In addition, as an option, it is also possible to install a single or double acting auxiliary hydraulics outlet in the rear of the machine, or a double acting outlet in the front under the multi connector.

⑦ ROPS safety frame

ROPS frame (Roll-over protective structure) complies with the standard ISO 3471:1994 with Amendment 1:1997 and Technical Corrigendum 1:2000.

⑧ FOPS canopy

FOPS canopy (Falling objects protective structure) mounts on the ROPS. It meets the ISO 3449:2005 (1365 J) criteria.

Signs and decals



Make sure that the following signs and decals clean, undamaged and readable. If any of these decals is missing or is unreadable it should be replaced without delay. Ask for new decals from your local Avant dealer.

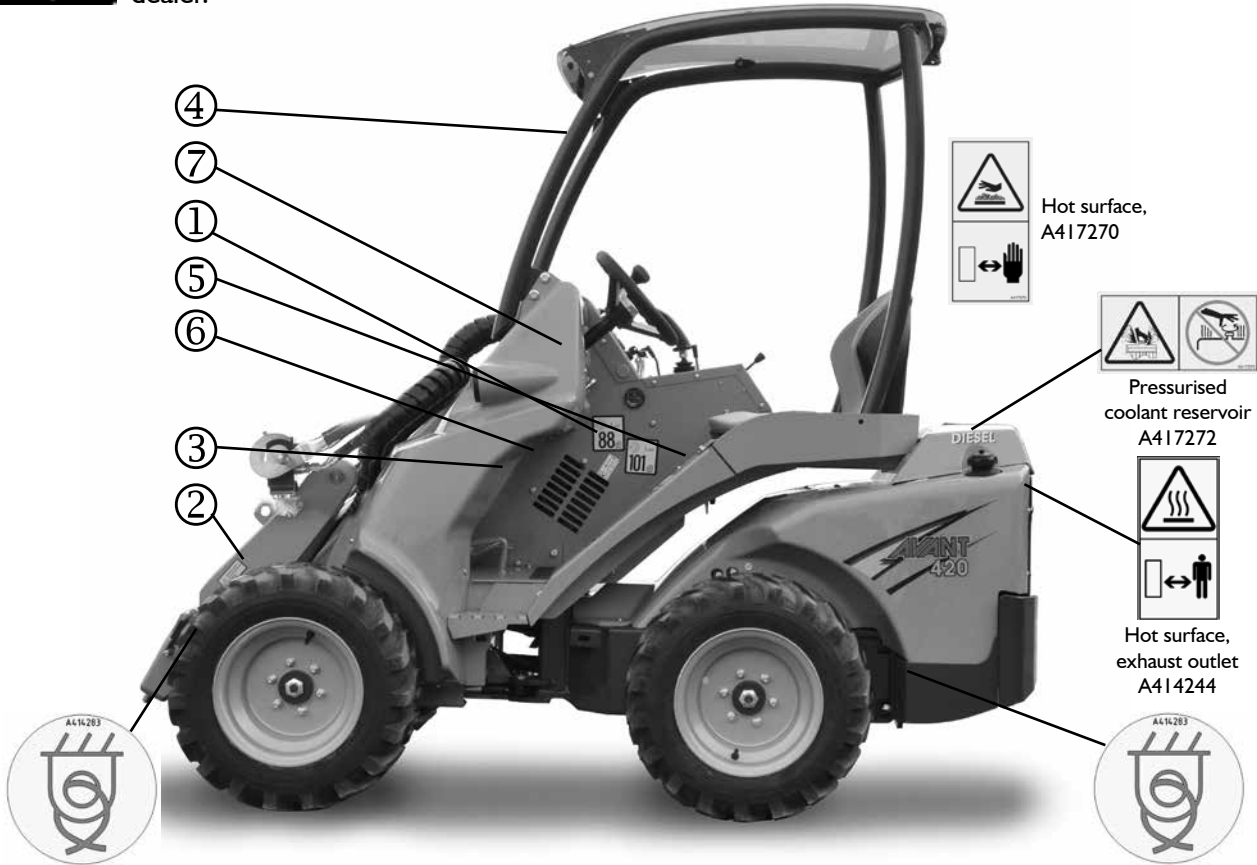

① A411047 A43600
Sound power level / Sound pressure level at driver's seat

② A417273
Keep out from the danger zone of the machine 2 pcs

③

④

⑤ A411456
Risk of crushing, keep hands and feet within the drivers' area

⑥ A411455
Risk of crushing, do not grip the steering wheel from outside the machine or when getting into the driver's seat.

⑦ A414690 A414664

Technical specification

Model	AVANT 420	AVANT 423
Length	2195 mm	2195 mm
Width	see table	see table
Height	1980 mm	1980 mm
Weight	1030 kg	1080 kg
Standard wheels	23x8.50-12"grass/TR	23x8.50-12"grass/TR
Transmission, drive	hydrostatic	hydrostatic
Pulling force	700 kp	700 kp
Drive speed	12 km/h	12 km/h
Hydraulic oil tank capacity	26 l	26 l
Hydraulic oil type	ISO VG 46	ISO VG 46
Auxiliary hydraulics oil flow / pressure	31 l/min 185 bar	34 l/min 185 bar
Turning radius inside/outside	880 / 1970 mm	880 / 1970 mm
Max. lifting height	2750 mm	2750 mm
Max. lifting capacity (hydr.)	690 kg	690 kg
Max. tipping load*	550 kg	550 kg
Max. breakout force / 50 cm	650 kg	650 kg
Sound pressure level 2000/14/EC L _p	81 dB (A)	81 dB (A)
Sound power level 2000/14/EC L _w	96 dB (A)	96 dB (A)
Hand-arm vibration, total	< 2,5 m/s ²	< 2,5 m/s ²
Whole-body vibration, max.	< 0,5 m/s ²	< 0,5 m/s ²

*) Load is measured at 400 mm from the attachment coupling plate, including attachment weight (70 kg) and with counterweights.

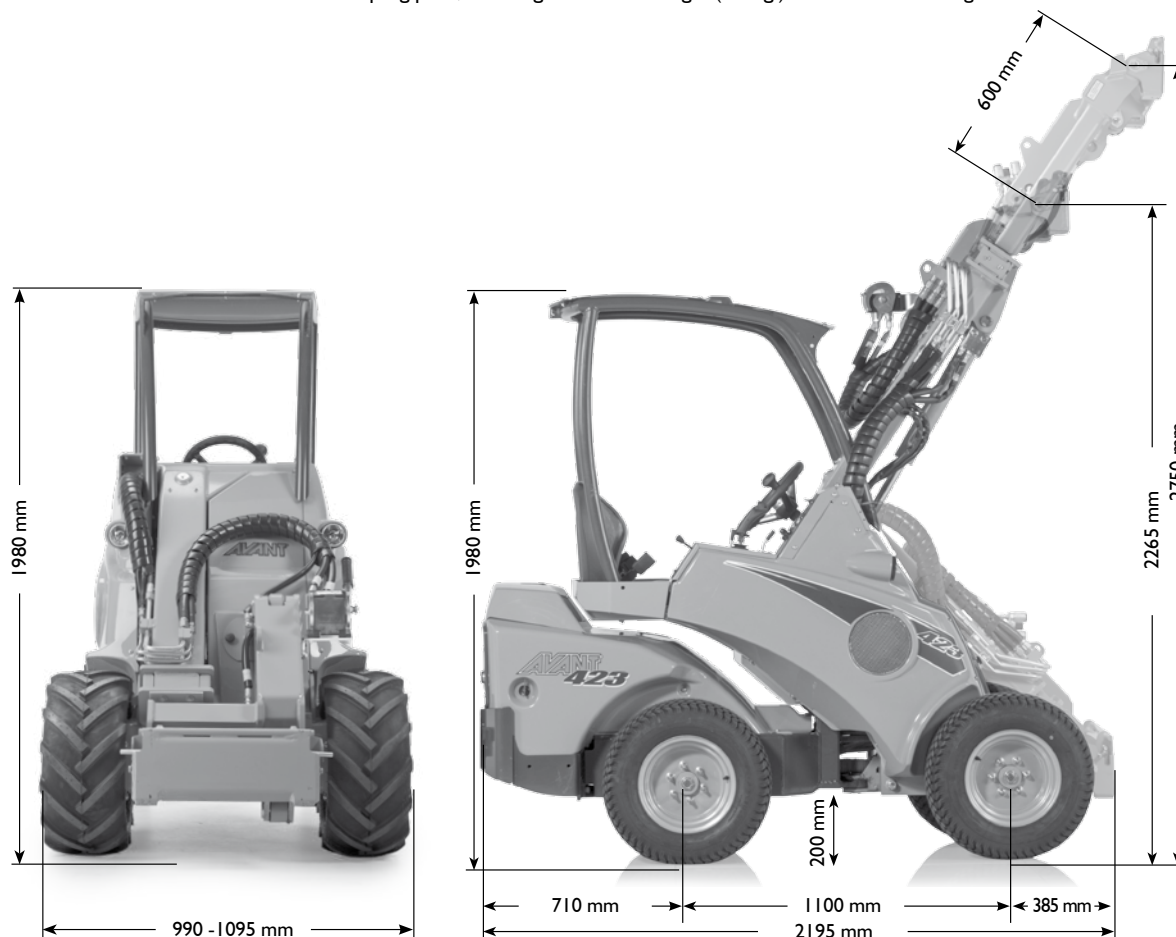

Engine specification

Model	420	423
Engine make and type	Kubota D722	Kubota D902
Function	4-stroke	4-stroke
Coolant	Water	Water
Number of cylinders	3	3
Starter	electric	electric
Bore x stroke	67 x 68 mm	72 x 73,6 mm
Displacement	719 cm ³	898 cm ³
Output (ECE R120)	14,9 kW (20 hp)	16 kW (22 hp)
Fuel	diesel	diesel
Fuel tank capacity	20 l	20 l
Engine oil type	API CC	API CC
Viscosity	SAE 10W-30	SAE 10W-30
Engine oil capacity	3,8 l	3,7 l
Charging current max.	40 A	40 A

Tyres

The loader can be equipped with different type of tyres for different operating conditions. Grass pattern (GR) tyres will damage the ground surface less than tractor (TR) tyres, but provide less traction.

Tyres	Tread pattern	Part no.	Pressure	Machine width	Fits with snow chains
5 x 10	TR	65412	2,7 bar	990 mm	64055
23x8.50-12	GR	65045	2,0 bar	1050 mm	64455
23x8.50-12	TR	65046	2,0 bar	1050 mm	64455
23x10.50-12	GR	65047	2,0 bar	1095 mm	64745
23x10.50-12	TR	65048	2,0 bar	1095 mm	64745

For the best stability and controllability, always use the largest tyres possible. Tyres that are narrower than the standard tyres are intended for special purposes only with width restriction on the machine. Use only tyres and rims that meet the original specifications and dimensions to avoid potential issues with load capacity, tyre size, or bearing load on drive motors. Consult your dealer if further information is needed. Special tyres, such as studded wheels may also be available. Consult your dealer for further information.

Auxiliary hydraulics oil flow

Max. auxiliary hydraulics oil flow can not be used with all attachments. Check correct engine rpm and auxiliary hydraulics pump configuration for the attachment with the help of this graph and the Operators Manual of the attachment.

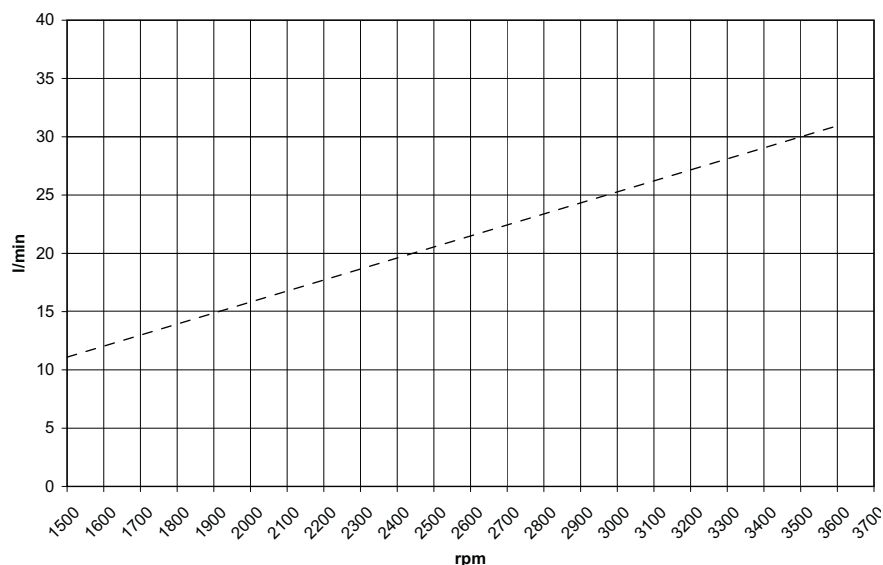

Load diagram

The lifting capacity of the loader is limited by the possibility of tipping around the front axle. The diagram below shows the tipping loads and max. allowed loads in different loading situations on an even level surface with the loader chassis in maximum articulation.

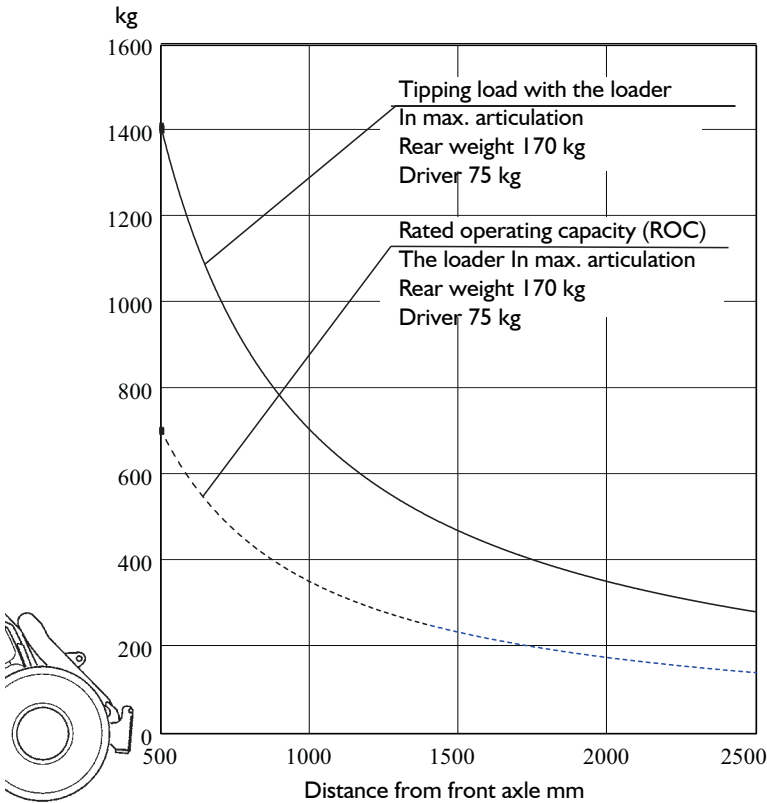

The diagrams can be interpreted as follows:

- The diagrams show tipping load and max. load with the load at different distances from the front axle of the loader
- Example: If the center of gravity of the load is 750 mm in front of the front axle, max. load is about 470 kg with a driver weighing 75 kg and with the 170 kg integrated rear weight mounted on the loader.
- **NOTICE:** If the driver leaves the machine, tipping and max. loads are reduced respectively.
- Tipping load and max. load depend both on the weight of the driver and the eventual extra weights mounted on the loader.
- Please note that the diagrams are based on the machine operating on a level, even and firm supporting ground. Loads should be significantly reduced when operating on gradients and/or on soft ground.
- Read the safety instructions regarding handling of heavier loads.

Transporting instructions and tie down points

Mount the articulation frame lock, shown on page 28, on the machine during transports. Lower the boom down and take off battery disconnect switch. Remember to remove the frame lock after transport!

Tie down points are located on the rear frame on the sides, and on the front frame close to the boom. Optionally available are the rear bumper and / or behind the rear wheels installed tie down brackets (Art. A418746), in which the straps and slings can be attached.

If absolutely necessary, the loader can be towed with a rigid tow bar, by releasing the hydraulic drive circuit. Max. allowed towing speed is 3 km/h, towing distance max. 200 m.

When the drive circuit is released for towing, the loader has no brakes. Before releasing the drive circuit make sure that the parking brake has been engaged, and release the parking brake only after a rigid tow bar has been connected.

The hydraulic drive circuit is released by turning the screw on the right side of the variable displacement drive pump about 3 rounds counterclockwise. Make sure to put the drive circuit again in working order by retightening the screw immediately after towing. Contact Avant service for instructions if necessary.

The loader can be lifted by mounting appropriate lifting slings on the ROPS frame. Before lifting, the attachment and eventual extra weights must be removed. Mount the frame lock on the machine. Make sure that the lifting slings cannot move and that the machine doesn't swing during lifting. Follow the instructions given in the operator's manual of the lifting slings.

Lift a loader with ROPS frame with four straps or slings approved for lifting and minimum 2 metres in length. Loop the lifting straps around the four ROPS posts.

Lifting kit A418706 includes all necessary parts to lift a loader with ROPS frame with detailed instructions included.

Lower the boom and mount the articulation frame lock as shown on page 28. Remove heavy attachment and extra counterweights before lifting. Never lift a loader with persons riding the machine.



Eyelets on extra side counterweights are for installing or removing the sideweight only. Never attempt to lift the loader from the counterweights or use them as tie-down points.

Operating instructions

Operating controls

Following picture shows the location of operating controls. The location and function of controls may be slightly different in different models, see following pages.



1. Steering wheel
2. Drive pedal, left: drive backward
3. Drive pedal, right: drive forward
4. Parking brake handle
5. Control lever of boom and bucket
6. Hand throttle lever
7. Auxiliary hydraulics control lever
8. Control lever of telescopic boom
9. 12 V outlet
10. Dashboard
11. Hour meter

12. Switches on the panel

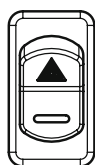

Emergency
blinker
(option)



Work light
(option)



Windscreen
wiper and
washer
(Cab option)



Front/rear auxi-
liary hydraulics
selector switch
(option)



Beacon
(option)

Control of loader boom, auxiliary hydraulics and other functions

Most of the functions of the loader are controlled at the control panel on the right side of the operator: Boom and bucket movements, auxiliary hydraulics (attachments), engine revs etc. , depending on loader model. Following pictures show the different functions:



Attachment control switch pack (option)

- Optional extra with which electric functions of the attachment are controlled
- Consists of 3 pcs control switches, wiring and a 7-pole socket which mounts on the auxiliary hydraulics multi connector (see page 8). The corresponding socket of the attachment electric wire is mounted on the attachment multi connector. This way both the electric wire and the hydraulic hoses of the attachments are connected at the same time with the multi connector.
- Read the operator's manual of the attachment to see how the switches are used with each attachment.

5. Control lever of boom and bucket

(Functions of the electric joystick are explained on page 19)

- Pull backward to lift the boom
- Push forward to lower the boom
- Push left to raise the tip of the bucket (filling)
- Push right to lower the tip of the bucket (emptying)

6. Hand throttle lever

- Push forward to increase engine revs
- Pull backward to reduce engine revs

7. Control lever of auxiliary hydraulics

(hydraulically operated attachments)





- Push right carefully to test the operating direction of the attachment
- For continuous operation of rotating attachments, push right & forward to locking position
- Pull left to operate the attachment in reversed direction
- When using the electric joystick, this lever will also move. Either way can be used to control the attachment as needed.

8. Control lever of telescopic boom

- Push right to extend the boom
- Pull left to retract the boom

Dashboard

On the dashboard on the right side of the driver's seat are mounted gauges, indicators and switches which help the operator to control the loader.

- 2. Headlamp indicator (Road traffic light kit)
- 4. Seat heater indicator 
- 5. Glow plug indicator 
- 6. Fuel gauge
- 7. Work light switch
- 10. Oil pressure indicator 
- 11. Charge indicator 
- 12. Thermometer
- 13. Ignition switch
- 14. Signal horn
- 15. Seat heater switch (optional extra)
- 16. Drive release / anti slip valve switch (optional extra)
- 17. Boom floating switch (optional extra)
- 19. Worklight indicator 



Controls in the footwell

Following picture shows the controls located in the footwell

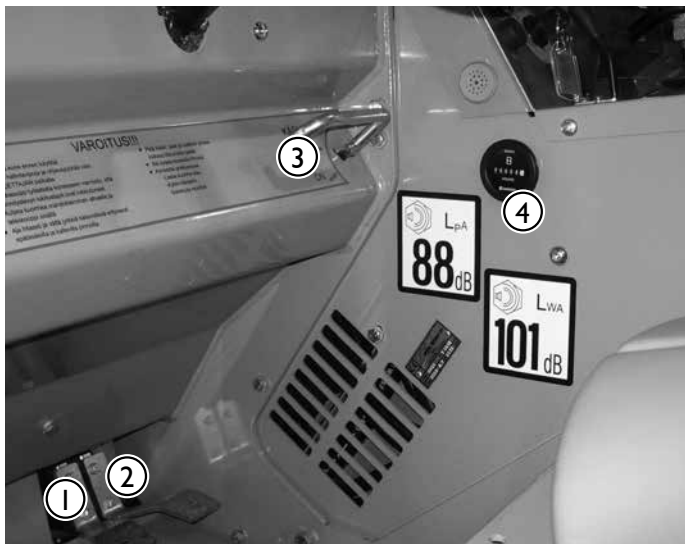

- 1. Drive pedal, left:** drive backward
- 2. Drive pedal, right:** drive forward
- 3. Parking/emergency brake handle**
 - locking: pull the handle and turn down into locking position
 - releasing: turn up and let the handle go down



Parking brake locks mechanically - spring-loaded pins go into the holes of the parking brake drum on the front wheels. Make sure that the brake locks properly by driving a bit forward or backward.

4. Hour meter

See correct operation of drive pedals on page 22.

Suspension seat (option)

The suspension seat is equipped with seat belt, arm rests and heater and has the following adjustments:

1. Suspension adjustment

- by turning the knob counterclockwise suspension gets harder, by turning it clockwise the suspension gets softer

2. Angle of the back rest

- the angle of the back rest can be adjusted by turning the knob

3. Seat position

- the distance of the seat from the steering wheel can be adjusted with the lever which is located under the front edge of the seat

4. Arm rest angle adjustment

- The angle of the arm rest can be adjusted by turning the roller under the arm rest



Seat belt and seat adjustments

Always use seat belt while driving. Make sure that the seat is properly adjusted to keep vibrations transmitted by the seat at minimum. Long term exposure to vibrations may cause health effects. Also, as far as possible, keep the operating terrain in good condition to minimize vibrations

Telescopic boom (option)

Telescopic boom is operated with the control lever no. 8 on the control panel (see page 15) or with the rocker switch on the joystick (see page 19). Length of the telescope is 600 mm and additional lifting height is 485 mm.



Battery disconnect switch

The loader is equipped with a battery disconnect switch. The switch is located in the rear of the machine, on the right side (see picture). Battery disconnect switch cuts the current between battery and the rest of the electric system. Always switch off main current when the loader is not used for a longer period of time in order that the battery doesn't get empty, or when servicing the machine.





Seat heater

The suspension seat is equipped with an electric seat heater. Seat heater switch (15) and indicator are located on the dashboard. 



Boom floating (option)

The floating system releases the lift cylinder, so that the boom floats upwards from the position where it is when boom floating is switched on, allowing the attachment to follow the contours of the terrain.

1. Lower the boom down
2. Switch on the floating with rocker switch no. 17 
3. Boom floating indicator  on the dashboard lights up



When boom floating is being used, it is possible that air gets in the hydraulic system. This can lead to inaccurate boom movements and the boom can give in. Therefore the boom and attachment coupling plate should always be moved to extreme end positions after switching off boom floating. Use boom floating only when necessary.

Joystick (option)

The loader is equipped, as an option with the 6 function joystick, where the operation of auxiliary hydraulics and telescopic boom is electric.

I. Auxiliary hydraulics

- push the buttons to engage and disengage auxiliary hydraulics.



Engine block heater (option)

The loader can be equipped, as an option, with an engine block heater. Engine block heater outlet (220V-240V) is on the right side in the rear of the machine.



Trailer coupling (option)

The loader can be equipped, as an option, with a trailer coupling. There are two types available: a 50 mm ball hitch and a 50 mm ball hitch with towing pin. Both can be mounted either directly on the rear bumper or on the extra back weight.

Max. allowed vertical load of the trailer coupling is 6900 N, max. towing load is 6000 N.

Make sure that the weight on the trailer is distributed correctly so that the trailer cannot cause an upward lifting force on the trailer coupling

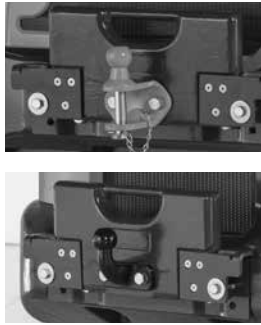

Extra counterweights (option)

The loader can be equipped with extra counterweights that are mounted on the rear bumper.

Max. amount of extra weights (29 kg/pcs) is 3 pcs. If the machine is fitted with an extra weight with trailer coupling, max. amount of extra weights is 1 pcs. The loader can also be equipped with an extra side weight kit (80 kg) which mounts behind the rear wheels.



Extra back weight 29 kg



Rear side weight (2x40 kg)

Work light kit (option)

The loader can be equipped with extra work lights, making it easier to work in low light. The lights are operated with the switch on the control panel (see page 14).



Headlight, beacon, blinker & reflector kit (option)

This optional equipment enables road traffic registration in certain countries. Requirements vary in different countries, please consult your local AVANT distributor.



Tilt adapter (option)

The hydraulic tilt adapter mounts between the attachment and the attachment coupling plate. It allows the driver to tilt the attachment sideways to both directions from the driver's seat. Tilt adapter is intended mainly for non-hydraulic attachments, but with the optional double acting extra auxiliary hydraulics outlet in the front (A35504) it is possible to mount a hydraulically operated attachment (e.g. a 4 in 1 bucket) at the same time. Tilt adapter is operated with the auxiliary hydraulics control lever (no. 7, page 15).



Drive release valve

The switch no. 16, LOCK, controls a valve, which is used to divert the oil flow between left and right side hydraulic motors, and this affects the pulling force.



LOCK OFF: In this mode, the hydraulic oil flows in series from motor to motor. The wheels will roll more freely and the loader leaves less tire marks on soft surfaces.

LOCK ON: In this mode the hydraulic oil flows in parallel between the hydraulic motors in each side, similar to a differential lock in operation. This improves the towing capability of the loader.

Anti slip valve (option)

The valve positively diverts oil flow between the right and left side hydraulic motors and improves traction on slippery and uneven surfaces. It is engaged by switch no. 16:



LOCK ON : Anti slip valve diverts oil flow between all four hydraulic motors - all four wheels have best possible traction. Use sufficient engine revs and press properly on the drive pedal.

LOCK OFF: Drive circuit released – anti slip valve diverts the oil flow between the front left and right hydraulic motor only, not the rear hydraulic motors.

Extra auxiliary hydraulics outlets, front and rear (option) Cab L (option)

In addition to the standard auxiliary hydraulics outlet, the loader can be equipped with a double acting extra outlet. The extra hydraulic outlet can be fitted either to the front of the loader or to the rear, and the couplers are conventional type quick couplers. The installed extra outlet is controlled with the lever no. 9 (see page 15). The loader can be equipped with either the rear hydraulics outlet or with the extra front outlet – but not with both.

1. Extra auxiliary hydraulics in the front

- Quick couplers are located under the multi connector



pressure 1 pressure 2

2. Quick couplers in the rear

- Quick couplers are located on top of the radiator.

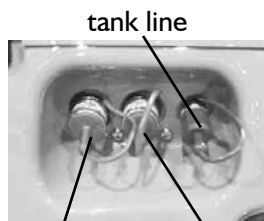

tank line
pressure 1 pressure 2

Double acting outlet

Warning beacon (option)

The beacon can be removed quickly by unturning its retaining screw and then by pulling the beacon out. Place the protective seal on the beacon stand to prevent water entering and damaging the connectors. Handle beacon with care. The beacon is sealed and its inner components cannot be replaced or repaired by user.



Avant 400 series can be equipped as an option with the cab L. It consists of windscreen, equipped with wiper and washer, right side window and rear window. Windscreen wiper/washer switch is on the dashboard (see page 14) and the washer tank filler cap is in the front chassis below the windscreen (see picture).



Beacon includes high-voltage components. Do not use or repair damaged beacon, replace with new one.

Starting the engine

Before starting the engine do the daily checks, see page 27. Adjust the seat and mirrors (if fitted) so that you have a good working position and unrestricted field of vision from the driver's seat. Check that all controls function correctly. See to it that the operating area is safe. Read and follow operating and safety instructions.

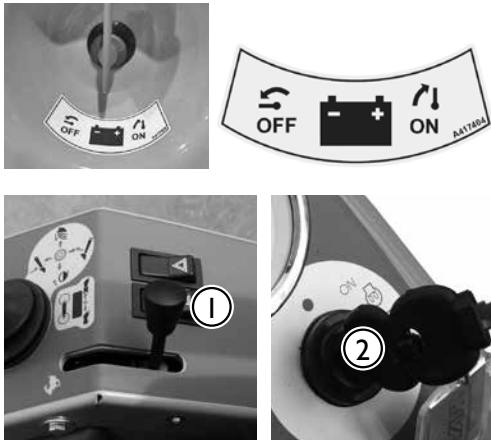

1. Turn the battery disconnect switch to ON
2. Move the hand throttle lever (1) to approximately 1/4 throttle
3. Make sure that auxiliary hydraulics is switched off (lever in neutral position). Do not press on the drive pedals.
4. Turn the ignition key (2) to the right until the glow plug indicator light (100) turns on.
5. After the glow plug indicator light turns off turn the ignition key further to the right until the engine starts.

Do not actuate the starter for more than 10 seconds at a time. If the engine does not start, wait for one minute before repeating attempt. If the engine does not start after a few attempts, or runs poorly, see troubleshooting on page 37 and the engine owner's manual.



If auxiliary hydraulics is switched on during starting and there is a hydraulically operated attachment on the machine, the attachment can move suddenly and cause a dangerous situation. Make sure that the auxiliary hydraulics control lever is in neutral position during starting.



The engine cannot start if auxiliary hydraulics control lever (no. 7, page 15) is in locking position

Stopping the engine (Safe stopping procedure)

1. Lower the boom completely down. Place attachment firmly on the ground, engage parking brake, stop the attachment (move auxiliary hydraulics control lever to neutral position, see page 23), set engine revs to idle.
2. Stop the engine by turning the ignition key to the OFF position (to the left)
3. Release auxiliary hydraulics pressure (see page 15).
4. Prevent unauthorized use of the loader. Take off the ignition switch and turn the power off with the battery disconnect switch.

Stop the engine as soon as possible, if any of the following symptoms is observed. Find out the cause before restarting.

- The oil pressure warning light turns on during operation.
- A sudden and unusual noise is heard
- The colour of the exhaust fumes suddenly darkens or turns white.

Drive control



Familiarise yourself with the driving of the machine on low speed and on a flat, even and open place where unintended movements don't cause problems or danger. When you have learned how to drive on low speed, increase speed gradually and learn how to drive with higher drive speeds. Make sure that there are no persons in the operating area of the machine.

Principle of operation

AVANT 420/423 is equipped with a hydrostatic drive system, a variable displacement hydraulic pump in the drive circuit is proportionally controlled with the two drive pedals. Driving of the machine is controlled with the drive pedals and hand throttle. Suitable engine speed is selected with the hand throttle lever on the control panel, and desired driving direction and speed are controlled with the drive pedals. To get maximum pushing power push the pedals lightly – for higher travel speed push the pedal harder.

Drive control

- Driving forward: press gently on the right drive pedal until the machine starts to move slowly.
- To drive backward: press gently on the left drive pedal.
- When you wish to stop gently release the pedal by lifting of your foot, and the machine will slow and stop.



The hand throttle can be used to control engine speed also while driving. The basic rule is: use lower revs for lighter work and higher revs for hard work or for high travel speed.

The hand throttle also has an effect on the operation speed of a hydraulically driven attachment: the more throttle the faster the attachment operates. Make sure not to exceed max. allowed oil flow of the attachment.

When you want to have a high pulling force:

1. Use high engine revs
2. Press the drive pedal only lightly to select a relatively slow drive speed. This way the full output of the hydraulic system and the engine can be taken out. If the engine is overloaded while pushing, the pedal shouldn't be pressed further, but instead use higher engine revs and push pedal only a little.



Hydraulic oil temperature has an effect on the hydrostatic transmission of the loader. When ambient temperature is below 5° C, let the engine run and the machine warm up properly before starting to drive. Drive carefully until the machine reaches its normal operating temperature.



When hydraulic oil gets warmer, driving characteristics of the transmission change. When the oil is hot and hydraulic oil cooler has switched on, stopping distance of the machine can be longer than normally. If the machine is used constantly in high ambient temperatures, hydraulic oil type and viscosity must be suitable for these conditions. Contact Avant service.



Should there be a disturbance or malfunction in the hydrostatic transmission and consequently the braking force is not sufficient, engage the electric parking brake. The front wheels may lock immediately, use only in emergency.

Steering of the machine

Steering of the machine happens with the steering wheel. The steering wheel is hydraulically powered. A practical way of steering is to steer with your left hand on the knob of the steering wheel. This way your right hand is free to operate other functions.



Always remember – safety first. Test all the functions of the loader at an open and safe place. Make sure that there are no persons in the operating area of the machine and the danger zone of the attachment.



When driving, always keep the loader boom as low as possible. Risk of tipping over increases considerably when there is a heavy load on the loader (a heavy attachment or a big load in the bucket) and the boom is up when driving.



Never use a high drive speed when turning. In particular: when the loader boom is up the stability of the machine is much weaker when turning.



Remember that, when turning, the driver's seat extends beyond the turning radius of the wheels. Stay inside the safety frame (risk of collision and crushing).

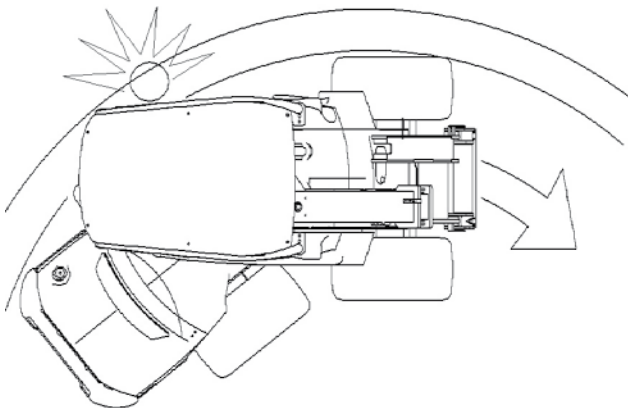

Pay attention to other machines and persons that are moving in the area. Make sure that there are no persons in the danger zone of the loader and the attachment. The danger zone of the loader covers the reach area of the loader boom, the turning area on the side and in the front and rear of the loader. Always put down the load when leaving the machine – the loader is not designed to stay with the loader boom and load lifted. Learn how to operate the loader in a safe place.

Loader control

The loader boom and bucket are controlled with the multi-function lever sideways (tilt) and back & forward (boom up & down).

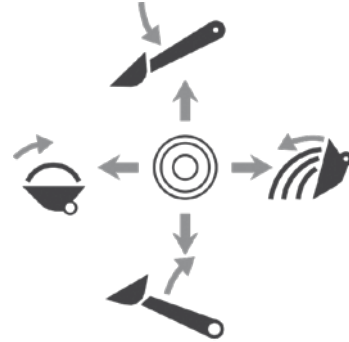

- Pull backward to lift the boom
- Push forward to lower the boom
- Push left to raise the tip of the bucket (filling)
- Push right to lower the tip of the bucket (emptying)

Using the auxiliary hydraulics

Auxiliary hydraulics (hydraulically operated attachments) are controlled with the lever no. ⑦ on the control panel, or with the buttons on the joystick (see page 18). The lever locks in the locking position (on the right) which facilitates operation of the attachments that require constant oil flow (rotary broom, backhoe etc.).



Make sure that the auxiliary hydraulics control lever is in its full forward position when locked on. Even a slightly incorrect position is enough to lower the effectiveness of the hydraulic system. Adjust the locking plate if needed.



Going near an attachment that is in operation can cause a serious risk. Switch off auxiliary hydraulics before leaving driver's seat or stopping the engine. Operate the controls only when sitting in the driver's seat.

Requirements for attachments



- Read Operators Manual of the attachment before starting operation. Make sure that the attachment is compatible with the loader. Contact your Avant dealer if necessary
- Check max. allowed hydraulic oil flow for the attachment. Adjust engine revs so that they are suitable for the work and the attachment.
- Make sure that the attachment is connected properly on the attachment coupling plate, and that it is being used in accordance with the instructions in the Operators Manual. Follow instructions regarding personal protective equipment and safety distances.
- Put the attachment down on the ground and stop the engine before leaving driver's seat. Familiarise yourself with the operation and stopping of the attachment at a safe place. Follow service instructions.

Coupling the attachments



Coupling of the attachments into the attachment coupling plate happens as follows:

Stage 1 :

- Lift up the two locking pins on both sides of the attachment coupling plate and turn them backward so that they remain in the up position
- Make sure that the pins remain in the up position, otherwise you cannot couple the attachment properly!



Stage 2 :

- Turn the attachment coupling plate with the tilt movement so that the upper edge of the plate leans forward.
- Drive the loader into the attachment



Stage 3 :

- Lift the boom a little so that the attachment lifts off of the ground
- Pull the boom control lever to the left so that the lower edge of the attachment coupling plate turns into the attachment



Stage 4 :

- Lock the lockin pins manually or use the hydraulic locking.
- Some attachments can be locked using the automatic return of the locking pins. See operator's manual of the attachment. If recommended, pull the boom control lever more to the left so that attachment coupling plate turns more and the brackets on the boom push the pins down in the holes of the attachment.
- Always make sure that the pins lock properly down in the holes of the attachment!

Coupling the hydraulic hoses of the attachment

Hydraulic hoses of the attachment are equipped with the multi connector system, which connects all hoses at the same time.



Coupling the multi connector

Align the pins of the attachment connector with corresponding holes of the loader connector. Connecting is not possible if the multi connector for some reason is mounted in a wrong way on the attachment hoses. Connect and lock the multiconnector by turning the lever towards the loader.

The lever should move easily all the way to locking position. If the lever doesn't move easily, check alignment and position of the attachment and loader side connectors and clean the connectors. Stop the engine and release pressure in auxiliary hydraulics line.

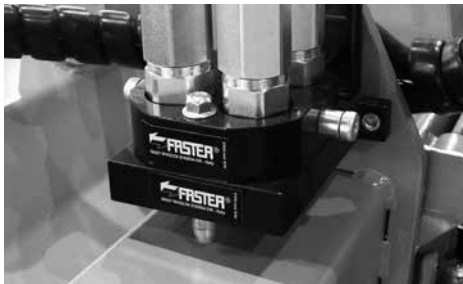

Disconnecting the multi connector

- Before disconnecting put the attachment down on a solid and even surface. Switch off auxiliary hydraulics. Disconnect attachment hoses by pressing on the red button on the multiconnector and simultaneously turn the lever away from the machine.
- After ending operation put the multi connector on its "parking" on the attachment.



When fitting an attachment, make sure that the hydraulic hoses are not overstretched and are not in a position where they can be trapped during the operation of the machine and attachment.

Make sure that the attachment is locked to the loader



Make sure that the attachment is properly connected on the attachment coupling plate. An attachment that comes loose may tip over or fall on the loader, causing personal injuries.



Do not try to lock the locking pins by using the brackets on the boom when the attachment is lifted over one metre from the ground. Lock the locking pins by hand and make sure that both pins lock properly down in the holes of the attachment.



Always read also the additional instructions for coupling and using of the attachment in the Operators Manual of the attachment.

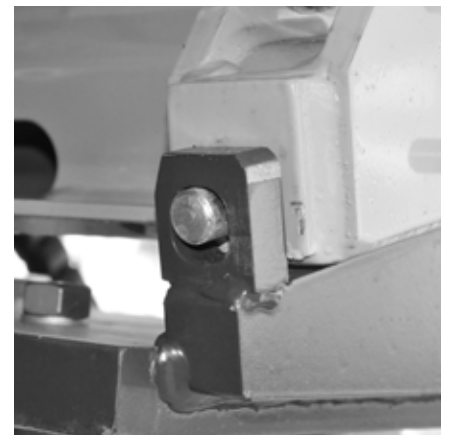

Releasing the pressure of hydraulic system

Make sure that there isn't pressure in the hydraulic system that could cause danger during service operations. In order to release the pressure in hydraulic system stop first the engine and lower the boom down completely. Move all control levers, including control lever of telescopic boom and auxiliary hydraulics, to extreme end positions a couple of times. Remember that the boom or attachment can move when releasing the pressure. Move the levers until all movements have stopped.

Service and maintenance instructions

Service parts are available through your Avant dealer or authorized service.



If you are not sure about how to do any service operation, ask for additional information before starting servicing. Contact Avant service.

Safety instructions for maintenance

- Stop the engine and let it cool down before starting any service operation.
- Put the service support on the boom lift cylinder when working under the boom.
- Install the frame lock when lifting the machine, for instance when changing tyres
- Before working on the engine or equipment, disconnect the battery.



Check hydraulic hoses for eventual cracks and wear. Follow the wear of the hoses and stop operation if the outer layer of any hose has worn out. If there are signs of oil leakage, put a piece of cardboard under the probable leakage place in order to find the leakage. If you find a fault, the hose or the component must be replaced. Contact your Avant dealer or service for spare parts.

Check hydraulic hoses and components only when the engine is stopped and hydraulic pressure is released. Repair all leaks as soon as you have noticed them, because a small leak can quickly change into a big one. Do not operate the machine if you have noticed faults or leaks in hydraulic system. Leaking hydraulic fluid can cause serious personal injuries and is harmful to the environment.

If the loader is equipped with the smooth drive option, a pressure accumulator is fitted to the boom hydraulic circuit. Do not disconnect any hydraulic component before the accumulator has been isolated from the circuit and the residual pressure has been released.



Never handle pressurized hydraulic components, because ejection of high pressure hydraulic fluid can cause serious injuries. Never use hands to search for leaks. Do not operate the machine if you have noticed a fault in the hydraulic system. Consult a doctor immediately if hydraulic fluid penetrates your skin.



Wear protective glasses and gloves when servicing the machine.



The fluids in the machine are harmful to the environment. Take waste oil and fluids to recycling station.

Installing of service support and frame lock



The red service support of the boom lift cylinder is located at the tip of the boom, behind the attachment coupling plate. Make sure that the boom stays up during maintenance operations by putting the service support on the lift cylinder piston rod. Secure the service support by locking it on the piston rod with the long screw that is on the support.

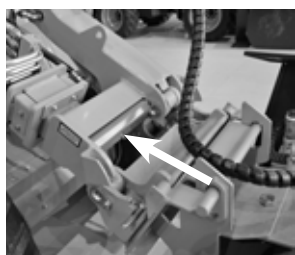

The frame lock is located over the articulation joint, under the seat base, and is fastened with a bolt.

The frame can be locked with the red frame lock. This way the loader frame stays straight during e.g. transportation. Install the frame lock in the holes on the front and rear frame and secure it with the cotter pin.



Daily inspections

- Tyre pressure
- Boom movements
- Drive control and steering
- Eventual need for lubrication
- Cleanliness of engine compartment and radiators
- Eventual oil leakages
- Locking of attachment and locking pins on attachment coupling plate, function of attachment, position of attachment hoses
- General condition of the loader, telescopic boom tightness
- Condition of the safety frame, seat belt, lamps, and other safety equipment

Maintenance schedule

Following table shows the maintenance and service points and intervals. There are more detailed instructions about each service operation, in numerical order, on the following pages.

Loader		Every week	After 50h	Every 200 h/year
1	Check tyre pressure	■		
2	Clean the machine	■		
3	Grease the machine	■		
4	Battery check		●	●
5	Check hydraulic oil level	●		
6	Check coolant level	●		
7	Change hydraulic oil filters		●	●
8	Change hydraulic oil		●	●
9	Check tightness of bolts, nuts and hydraulic fittings		●	
10	Check pressure of hydraulic system *)		●	■
11	Adjust pressure of hydraulic system *)		●	■
12	Check slide pads 1, 2, 3 and 4 on the boom	●	■	●
13	Adjust or change slide pads 1 and 2		■	●
14	Check/change slide pads 5, 6, 7 and 8			●
Engine				
15	Clean air filter element	■		
16	Replace air filter element			●
17	Check engine oil level	●	●	
18	Change engine oil		●	●
19	Change engine oil filter			●
20	Check condition and tightness of alternator belt			●
21	Check water hoses and hose clamps			●
22	Change fuel filters			●
23	Clean radiator cells	●		●
24	Change coolant			■

● Maintenance operation

■ When necessary

*) A 250 bar pressure gauge, equipped with manometer fitting, is required for checking the pressure of the boom lifting and auxiliary hydraulics.

2. Cleaning of the machine

Cleanliness of the loader is not only a question of outer appearance. All surfaces, painted and others, will stay in better condition when they are cleaned regularly. A dirty machine will run hotter and will collect more dirt into the air cleaner, which may shorten the engine life. Pay special attention to the cleanliness of the engine, the engine compartment, the radiators, the hydraulic pump compartment, hydraulic quick couplings and the oil tank cover. The outer surfaces of the loader can be washed with a pressure washer. However, avoid direct spraying on hydraulic components (hoses, cylinders), decals, and the radiators. Clean cab interior with appropriate mild detergent and cleaning supplies. After washing grease all greasing points, also the attachment coupling plate and locking pins.



The loader is equipped with a hydraulic oil cooler, which is located in the front frame on the right side. Make sure to clean the oil cooler cell with compressed air every time you are servicing the loader - and even more frequently if the loader is being used in dusty conditions. Take off the right side cover plate before cleaning the oil cooler.

3. Greasing of the machine

Greasing of pivot points is very important in order to avoid wear. Most of the greasing points are on the loader boom. The picture on page 35 shows the location of grease nipples.

4. Battery check

Inspect and clean battery terminals regularly. Check also condition and fastening of battery cables and terminal insulators. Make sure that battery cables cannot chafe against any sharp edges. Check also condition and fastening of battery disconnect switch and cables.

5. Hydraulic oil level

Hydraulic oil level can be checked with the dipstick in the filler. Oil level should be at the lower mark of the dipstick when the loader boom is up. Refill when necessary. Do not let any contaminants enter the hydraulic oil tank during this procedure. There is a breather filter inside the dipstick cap which should be cleaned or changed once a year. **Remember to use the service support (page 28).**



6. Check coolant level



Never open the pressurized radiator while engine is warm. Hot coolant may burst out causing serious burns. Allow engine to cool completely before opening.



7. Changing of hydraulic oil filters

The hydraulic oil return filter is located on top of the hydraulic oil tank, under the front cover. Take off the cover and replace the oil filter cartridge.

Remember to use the service support (page 28).

The hydraulic pressure filter is located in the back frame beside the hydraulic pumps. When unscrewing the filter hold the screw in the housing with a 12 mm allen key and replace the filter.



8. Hydraulic oil change

When changing hydraulic oil, the oil can be removed with a suction pump or by opening the drain plug on the right side of the front frame, next to the articulation joint. In both cases it is important to clean the magnetic drain plug. Hydraulic oil tank capacity is 26 litres. Use ISO VG-46 certified mineral hydraulic oil.



Use of synthetic or bio hydraulic fluids is not allowed.



9. Check and tightening of bolts, nuts and fittings

Check tightness of bolts, nuts and hydraulic fittings regularly. However, do not overtighten; tighten hydraulic fittings only if necessary. Wheel nuts should be tightened 250 Nm.



Tighten wheel nuts after first 5 operating hours. Check tightness of wheel nuts regularly.

10. Check pressure of hydraulic system

Pressure checking points and pressure settings for different functions are as follows:

Auxiliary hydraulics: Pressure is checked by mounting the manometer in the female auxiliary hydraulics quick coupling, with full revs and by turning the aux. hydraulics control lever. Pressure is measured with full engine revs. Pressure setting should be 185 bar.



Drive pressure: In order to check the pressure in the drive circuit one needs to mount a pressure gauge in the pressure line in each and every case, if pressure seems to be clearly wrong. There are two pressure relief cartridges which have fixed 280 bar pressure setting.

It is recommended that pressures should only be checked by a competent and experienced technician. Call your AVANT dealer if you need assistance.

11. Adjust pressure of hydraulic system

If the pressure of hydraulic system does not seem to be correct or pressure check indicates that the pressure is wrong, it can be adjusted. All adjustment screws are protected with a 13 mm nuts and there is a seal ring under each nut. When taking off the nuts make sure that the seal rings doesn't get lost. Adjust the pressure with an allen key, max. 1/8 rounds at a time. See pictures for pressure adjustment points.

Auxiliary hydraulics: Pressure is adjusted from the pressure relief valve at the main control valve. Pressure adjustment screw is on the right, on top of the valve segment (see picture). Adjust by turning the screw with a screwdriver. Pressure setting should be 185 bar.



Drive pressure: Can not be adjusted. If the pressures are clearly wrong one must change the pressure relief cartridges which have 280 bar fixed pressure setting.



Never exceed the recommended hydraulic pressure settings. Excessive hydraulic pressure will damage or wear the hydraulic pumps, cylinders, and hydraulic motors.



Warranty does not cover damages caused by excessive hydraulic pressure.

12-14 Adjust and change the slide pads on telescopic boom

The telescopic boom is equipped with replaceable slide pads. At the lower end of the outer boom there are nylon slide pads. 1, 2, 3 and 4. In addition, there are four aluminium-bronze alloy slide pads (nos. 5,6,7 and 8), at the upper end of the inner boom. All slide pads can be replaced, and the nylon slide pads on the outer boom can also be adjusted. This way the natural wear of the slide pads, caused by the use of the telescopic boom, can be compensated.

Slide pads 1 to 4 can be adjusted by mounting thin adjustment sheets between the boom and the slide pad. Extend the telescope almost completely and press the boom against the ground, it is the easiest way to mount the adjustment sheet under slide pad no. 2. However, if there is substantial wear in the slide pads it is advisable to replace both pad no. 1 and 2.

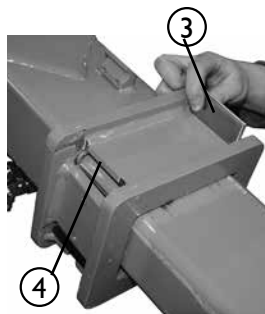
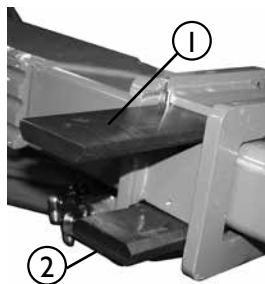

Slide pads 5 to 8 at the upper end of the inner boom last very long in normal use. Slide pads 5, 6, 7 and 8 should be checked after every 400 operating hours and replaced at least after 800 hours. Checking is made by taking the inner boom completely out of the outer boom. If the pads have worn so much that they are in level with the boom, or excessive boom play can't be removed by adjusting slide pads 1 to 4, replace all slide pads.

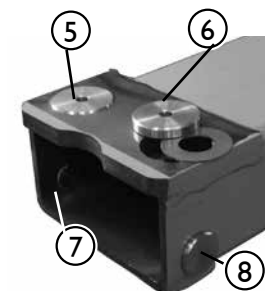

Part nos. for the slide pads are:

Slide pad 1 and 2: A48339

Slide pad 3 and 4: A48340

Slide pad 5 and 6: A47922

Slide pad 7 and 8: A48343

Washer under slide pads 5 and 6: A47941

Adjustment sheet, short: A48013

Adjustment sheet, long: A48014

15.-16. Clean air filter element

1. Squeeze the rubber vent on the filter housing cover to drain water and dirt from the filter.
2. Wipe the outer surface of the air filter housing clean before opening the filter.
3. Remove the filter cartridge
4. To clean the filter, tap the closed end of the filter gently against a flat, clean surface. Never use compressed air to clean the filter!
5. Do not remove the inner element.
6. Clean the inner components of the filter housing with a damp cloth
7. Reinstall cartridge, ensure proper tightness and sealing of the filter and the housing cover.

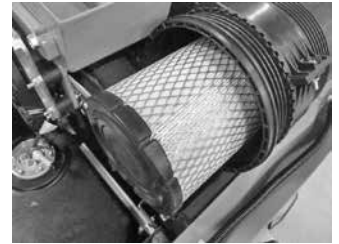

17.-24. Service, engine

AVANT 420/423 is equipped with a Kubota diesel engine (see technical specification sheet for the engine type of each model). Service and maintenance instructions for the engines can be found in the Kubota Operator's Manual supplied with the loader.

Fuses

In the event of electric malfunction, always check the fuses first. If fuse is blown repeatedly, search for cause of burning fuse. Electric cables may be damaged. Contact service.

Main fuse box L and ROPS

located outside the cab, on the right side of the loader boom.

On loaders equipped with ROPS canopy or cab L, lift the boom first for easier access to the main fuses, if possible. Remember to use the service support. If the boom cannot be lifted, the fuses can be checked after removing the right side cover plate.

25A	12V ulosotto, etu jatkuva Perävaununpistoke
25A	Tieliikennesarja
20A	
10A	Vaihte/jarru 750
30A	12V ulosotto, etu Hydr. työlaitekiinnitys
15A	Lisätövalot Etu-ulosoton kahdennus
25A	Hydrauliolijynjäähdytin
10A	Merkkivalot Mittaristo Äänimerkki
20A	12V ulosotto, kojetaulu Standard työvalot
20A	Puomin kellunta Takanostolaite
25A	Hytti: pyyhin-pesuri Hytti: puhallin
15A	Joystick Istuinlämmitys Etu-/takaulosoton valintakytkin 400/500

Hydraulic oil cooler fan fuse

The red indicator no. 18 on the dashboard indicates blown hydraulic oil cooler fan fuse. If the indicator is lit, check the 25A fuse of the oil cooler fan. Contact Avant service if necessary.

Jump start and auxiliary power

The engine can be started with auxiliary power if necessary, by using appropriate (strong enough) jump start cables. Connect first one end of the positive cable to the positive (+) post of the dead battery. Then connect the other end of the positive jumper cable to the positive (+) post of the charged battery. Connect one end of the negative jumper cable to the negative (-) post of the charged battery. Then connect the other end of the negative jumper cable to a solid, non-paint coated metal part of the engine of the dead loader, as far from the dead battery as possible.



Read Operators Manual of the vehicle that is giving auxiliary power, in order to make sure that the vehicle suited for that. The vehicle can get damaged when giving auxiliary starting power.



Never bypass battery or connect cables directly to starter motor. Engine may get damaged.

Storage of the machine

Before long term storage clean the loader carefully and check and touch-up painted surfaces if necessary in order to avoid rust damages. Grease the greasing points and put oil on piston rods of the cylinders. Take off the battery and store it in the right way. It is recommended to perform the yearly service before storage. Store the machine indoors if possible. If outdoors storage is necessary, protect the machine with the designated cover (part no. 65478). See the engine owner's manual to prepare the engine for long term storage and how to start it after long storage period.

Refueling

Check fuel level and fill the tank if necessary. Make sure to add fuel before the fuel tank gets empty. Should this happen, a manual bleeding must be performed before restart. If possible, refuel the loader after use to prevent condensation of water into the fuel tank.



Use only clean fuel and take care when refueling the loader to avoid dirt and water from entering the fuel tank. Clean fuel cap and surroundings before opening the cap. Always store fuel properly in an approved container. Water in fuel can cause severe damage to engine injection system.



Always stop the engine and allow it to cool before refueling. Do not spill fuel when refueling. Should this happen, wipe the fuel away immediately in order to avoid risk of fire. Keep fuel away from sources of ignition. Do not smoke during refueling.

Check all fuel lines for tightness and wear on a regular basis. Tighten or repair them as needed. Check fuel system thoroughly and clean the fuel tank after every 2 years.

Metal structures of the loader



Contact Avant service in case the steel structure of the loader gets damaged. A faulty reparation can cause a dangerous situation.



In case the ROPS safety frame or the FOPS canopy of the machine gets damaged, the machine must be taken to Avant service for checking. It is not allowed to repair the ROPS and FOPS.

AVANT[®] 400 Series Service and maintenance instructions

Greasing points

Following pictures show the location of greasing points.

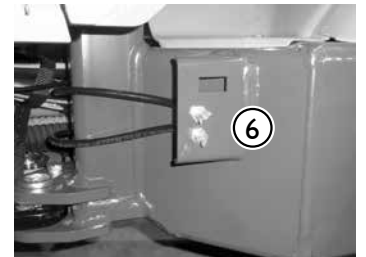
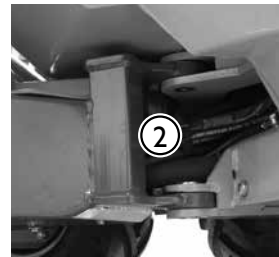
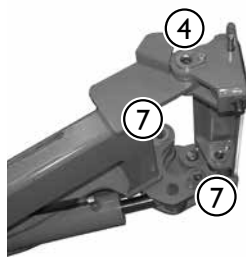
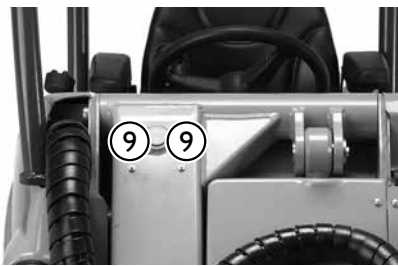
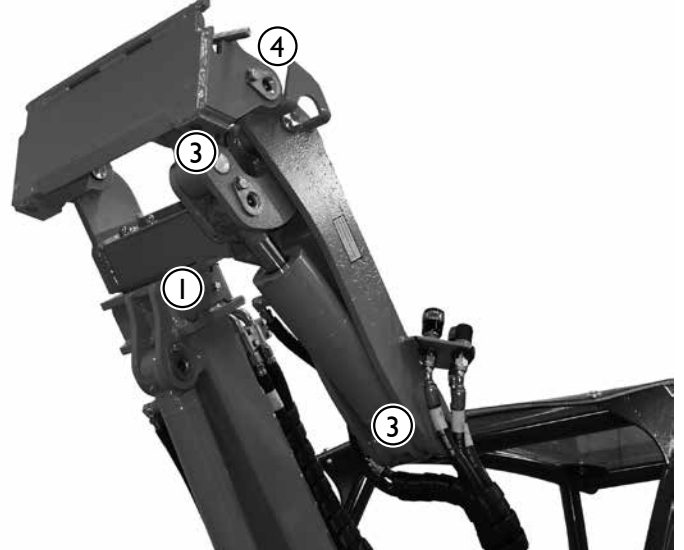

Greasing points		pcs.
1.	Lift cylinder, both ends	2
2.	Steering cylinder, both ends	2
3.	Tilt cylinder, both ends	2
4.	Pivot pins on attachment coupling plate/boom	2
5.	Pivot pin on loader boom	2

Greasing points		pcs.
6.	Articulation joint	2
7.	Tilting mechanism	3
9.	Telescopic boom, grease with boom completely retracted	2



Check the tightness of the pivot pin locking screws, if loose tighten and use thread locker.

Light bulbs

Light bulb		Lamp type
1.	Front light and work lights	LED
2.	LX/DLX Headlamps	H4

Filters

Following pictures and tables show the location and part numbers for the filters.

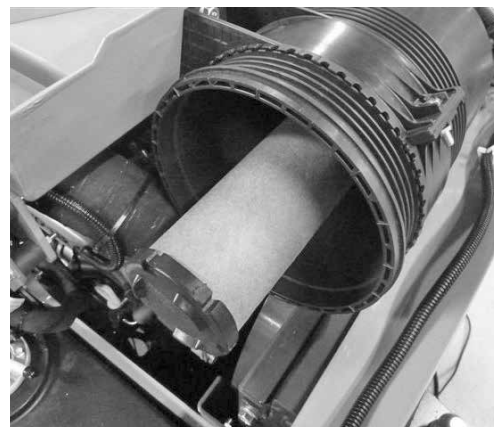
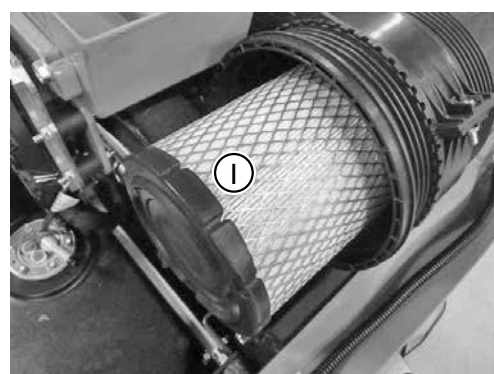

Avant filters		Avant 420	Avant 423
1.	Air filter	64712	66516
2.	Fuel filter	64626	64626
3.	Fuel filter, pre filter	64657	64657
4.	Engine oil filter	64207	64207
5.	Hydraulic oil filter, return	74093	74093
6.	Hydraulic oil filter, pressure	64807	64807
Filter kit		A416943	A425525

7. On Avant 420/423 there is also a water separator with a filter in the fuel system. This water separator filter is not included in the filter kit and it needs not to be changed, unless it breaks. Part no. for the water separator filter is 64963.

Air filter, inner screen element
(replace only when necessary)
64713 (420), 66517 (423)

Troubleshooting

Problem	Possible cause	Remedy
Engine does not crank	Main switch off	Turn on the main switch
	Battery discharged, battery voltage too low	Check and charge
	Blown fuse	Check fuses. If fuse blows again, find out the cause. Contact service
	Battery cables poorly connected	Check battery cables and posts, clean and retighten if necessary
Engine cranks but does not start, or starts and stops immediately	No fuel or wrong type of fuel	Fill the tank with correct type of fuel.
	Engine does not get fuel, clogged fuel filter or fuel line	Fill the tank with correct type of fuel.
		Make sure that the fuel hoses and fuel filter are clean and have not been frozen. Replace fuel filter, clean fuel lines.
	Cold ambient temperature	Hold ignition key in glow position for longer period. If glow indicator lamp is lit, allow it to turn off before starting. Extend starting time up to 5 seconds. (Diesel)
		Use correct type of engine oil
	Auxiliary hydraulics control lever is in locking position.	Turn the lever in center (neutral) position.
Battery discharged or damaged.	Jump start with another battery (See page 34), then charge the battery or replace if damaged	
Engine overheats	Clogged radiator	Clean radiator and fan from engine side
	Coolant level low	Add coolant
	Leaking cooling system	Check coolant pressure reservoir cap for tightness. Check cooling system and all hoses and connections.
Hydraulic system overheats	Hydraulic oil level low	Check and refill, see page 30
	Clogged oil cooler	Clean cooler and fan
	Fan faulty	Check and clean, repair if necessary
	Hydraulic oil flow restricted	Make sure auxiliary hydraulics valve is completely opened when using high flow attachments. Adjust lever locking plate if necessary.
	Hydraulic system overloaded	Use attachment at lower engine rpm, use with 1-pump setting, check attachment for faults.
The loader does not move even after the parking brake has been released.	The pins of the parking brake mechanism have not locked properly in the wheels.	Drive slowly forward or backward in order to lock the parking brake.
	Parking brake engages the front wheels.	When releasing the parking brake do this in opposite order. If the machine must stay in a slope, park it so that the heavier end is on downhill side.

Services made

1. Customer _____

2. Loader model _____ Serial no _____

3. Date of delivery _____

Date of service dd / mm / yyyy	Operating hours	Remarks	Serviced by: Stamp/signature
___ / ___ / ____	_____ / 50 h		
___ / ___ / ____	_____ / 250 h		
___ / ___ / ____	_____ / 450 h		
___ / ___ / ____	_____ / 650 h		
___ / ___ / ____	_____ / 850 h		
___ / ___ / ____	_____ / 1050 h		
___ / ___ / ____	_____ / 1250 h		
___ / ___ / ____	_____ / 1450 h		
___ / ___ / ____	_____ / 1650 h		
___ / ___ / ____	_____ / 1850 h		
___ / ___ / ____	_____ / 2050 h		

EC DECLARATION OF CONFORMITY

1. Manufacturer: **Avant Tecno Oy**

**Ylötie 1
FI-33470 YLÖJÄRVI
FINLAND**

2. **We hereby declare that the machines listed below conform to EC Directives, as they are amended: 2006/42/EC (Machinery), 2014/30/EC (EMC) and 2000/14/EC (Noise Emission).**

3. Category: **EARTH-MOVING MACHINERY/LOADERS/COMPACT**

4. Model: **AVANT** _____

5. Serial Number: _____

6. Year of Manufacture:

7. Directive / Conformity Assessment Procedure / Notified Body:

2006/42/EC	Self-certification	-----
2014/30/EC	Self-certification	-----
2000/14/EC Annex VI	Type-test	Natural Resources Institute Finland, Measurement and Standardization NB 0504 Vakolantie 55, 03400 Vihti, FINLAND

8. Issuer of declaration and person authorized to compile technical construction file:

9. Name: **Risto Käkelä**

10. Position/Title: **Managing Director**

11. (Signature)  _____

12. Place: **Ylöjärvi, Finland**



AVANT[®]

Avant Tecno Oy
Ylötie 1
FIN-33470 YLÖJÄRVI, FINLAND
Tel. +358 3 347 8800
sales@avanttecno.com

AVANT has a policy of continuing improvement, and retains the right to change specifications without notice. © 2018 AVANT Tecno Oy. Kaikki oikeudet pidätetään.

www.avanttecno.com